



BASIA 2 (W)

Type: *BASIA 2/1.7W*

ID: BA102W



Management Service
ISO 9001: 2000

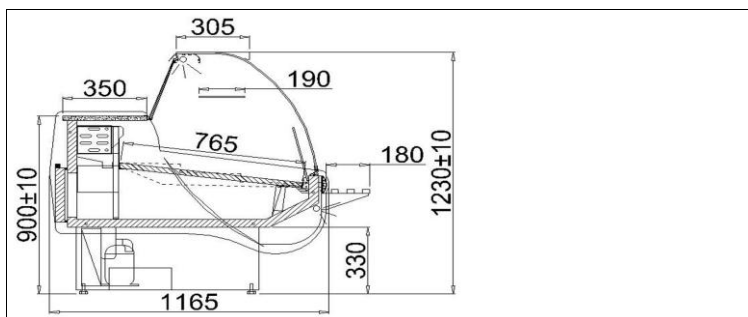

STANDARD

- internal refrigerating unit
- external housing made of zinc coated plate powder painted - white
- storage chamber made of stainless plate
- exposition area made of stainless plate
- aluminium sections - color selection possible - silver/gold
- electronic control with digital temperature display
- dynamic cooling
- automatic defrosting
- condensate outlet to container
- sound alarm indicating condenser impurity or fan operation failure*
- front panel warm air blast
- work surface - granite, grey
- high front panel - bent removable
- light - "meat" fluorescent lamp
- night roller blind
- back door
- ecological polyurethane foam insulation
- side panels of ABS plastic - color selection possible
- front fender - color selection possible
- device levelling stands
- exposition shelf of stainless plate
- * only using IGLOO thermostat

Colour scheme

Paint colors

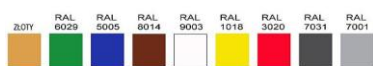

Base fender colors



Aluminium sections colors



Plexiglass colors



ABS sides



Technical parameters

| | |
|--|-----------|
| Cooling factor | R134a |
| Length with sides[mm] | 1670 |
| Depth[mm] | 1165 |
| Side thickness [mm] | 40 |
| Cooling power [W] | 605 |
| Rated power [W] | 363 |
| Rated power of lighting [W] | 36 |
| Rated voltage [V] | 230/50Hz |
| Shelf load [kg/linear metre] | 50 |
| Usable capacity of cold chamber [dm ³] | 270 |
| Cooling area of shelves [m ²] | 1,2 |
| Evaporation temperature To [°C] | -10 |
| Unit weight [kg] | 190 |
| Height [mm] | 1230+/-10 |
| Range of temperature [°C] | +2/+8 |
| Cooling power demand [W/linear metre] | 400 |
| Electricity consumption [kWh/24h] | 5,8 |

Additional chooser options

- light - "white" fluorescent lamp
- light - "confectionery" fluorescent lamp

Additional options add. cost

- automatic condensate vaporization
- work surface - granite, Balmoral
- front panel with light - Plexiglas color selection possible
- extra charge on front panel and/or base colour - colour selection possible
- base fender - color selection possible
- temperature recorder *
- plug with fuse
- front shelf for client
- exposition shelf of glass
- step exposition shelf (2 or 3 steps)
- reticulated shelf - white, plastified
- passing shelf - from stainless plate to glass
- Fixed vertical barrier (from the length of 1,7 up to 2,5)
- movable glass partition

-Air temperature + 25 °C, air humidity 65% -Data alteration reserved * -only using IGLOO thermostat