

Z.E.Ch. IGLOO product catalogue, group: Confectionery display cases



JAMAJKA (W)

Type: JAMAJKA 0.9W

ID: JA102



Management Service
ISO 9001: 2000

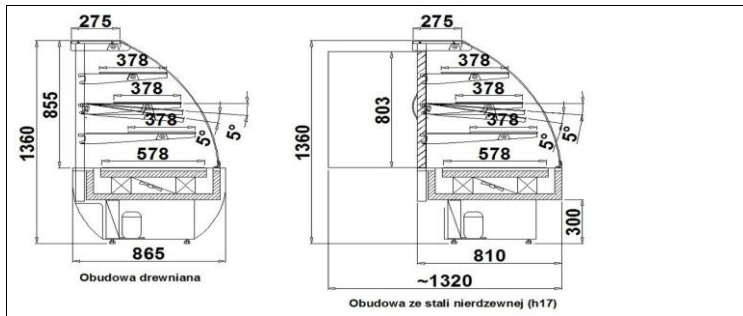

STANDARD

- internal refrigeration unit
- wooden casing - color selection possible (IGLOO template)
- electronic controller with digital temperature display
- dynamic cooling
- automatic defrosting
- automatic condensate vaporization
- sound alarm indicating condenser impurity or fan operation failure*
- front panel warm air blast
- high front panel, bent, made of hardened glass
- light - "confectionery" fluorescent lamp
- light for each shelf
- back sliding door with combined glass, self-closing
- ecological polyurethane foam insulation
- device levelling stands
- exposition shelves have height and installation angle adjustment possibility
- Gold-painted internal frame

Colour scheme

Wood colors



Aluminium sections colors



Technical parameters

Cooling factor	R134a
Length (wood/h17) [mm]	1000/905
Depth (wood/h17) [mm]	865/810
Side thickness [mm]	40
Cooling power [W]	464
Rated power [W]	509
Rated power of evaporator heater [W]	160
Rated power of lighting [W]	54
Rated voltage [V]	230/50Hz
Shelf load [kg/linear metre]	10
Usable capacity [dm ³]	305
Cooling area of shelves [m ²]	1,5
Evaporation temperature To [°C]	-10
Unit weight [kg]	150
Height [mm]	1360+/-10
Range of temperature [°C]	+4/+15
Electricity consumption [kWh/24h]	8,5

Additional chooser options

- device designed for line setup
- device designed for individual setup
- power by external refrigerating unit possible

Additional options add. cost

- external housing of stainless plate
- humidity control system
- temperature recorder *
- small tray
- large tray
- Jamajka 0.6 exposition space from stainless metal sheet
- Jamajka 0.9 exposition space from stainless metal sheet
- Jamajka 1.3 exposition space from stainless metal sheet

-Air temperature + 25 °C, air humidity 65% -Data alteration reserved * -only using IGLOO thermostat

Zakład Elektromechaniki Chłodniczej "IGLOO"

32-700 Bochnia, ul. Kazimierza Wielkiego 13

tel.: +48 14/ 662 19 10, fax: +48 14/ 662 19 12, e-mail: info@igloo.com.pl

