



SANTIAGO (S) - DRE

Type: *SANTIAGO 1.7S DRE*

ID: SA102/DRE



Management Service
ISO 9001: 2000

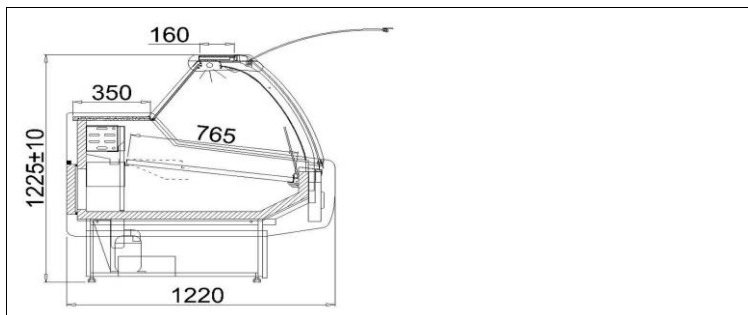

STANDARD

- internal refrigerating unit
- external housing made of zinc coated plate powder painted - white
- storage chamber made of stainless plate
- exposition area made of stainless plate
- wooden casing (sides and front of device) - color selection possible (IGLOO template)
- aluminium sections - color selection possible - silver/gold
- electronic control with digital temperature display
- gravitational cooling
- automatic defrosting
- condensate outlet to container
- sound alarm indicating condenser impurity or fan operation failure*
- front panel warm air blast
- work surface - granite, grey
- front panel lifting telescopic system
- light - "meat" fluorescent lamp
- night roller blind
- ecological polyurethane foam insulation
- device levelling stands

Colour scheme

Paint colors

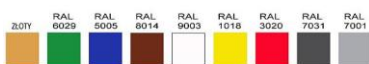

Aluminium sections colors



KOLOR WG WZORNIKA IGLOO

Technical parameters

Cooling factor	R134a
Length with sides [mm]	1690
Depth [mm]	1220
Side thickness [mm]	50
Cooling power [W]	530
Rated power [W]	341
Rated power of lighting [W]	36
Rated voltage [V]	230/50Hz
Shelf load [kg/linear metre]	50
Usable capacity of cold chamber [dm ³]	270
Cooling area of shelves [m ²]	1,2
Evaporation temperature To [°C]	-15
Unit weight [kg]	220
Height [mm]	1225+/-10
Range of temperature [°C]	+2/+8
Cooling power demand [W/linear metre]	350
Electricity consumption [kWh/24h]	5,3

Additional chooser options

- light - "white" fluorescent lamp
- light - "confectionery" fluorescent lamp

Additional options add. cost

- automatic condensate vaporization
- work surface - granite, Balmoral
- temperature recorder *
- plug with fuse
- step exposition shelf (2 or 3 steps)
- Fixed vertical barrier (from the length of 1,7 up to 2,5)
- movable glass partition

-Air temperature + 25 °C, air humidity 65% -Data alteration reserved * -only using IGLOO thermostat