



SANTIAGO (W) - MOD/A

Type: SANTIAGO 2.1W-mod/A

ID:SA103W-a



Management Service
ISO 9001: 2000

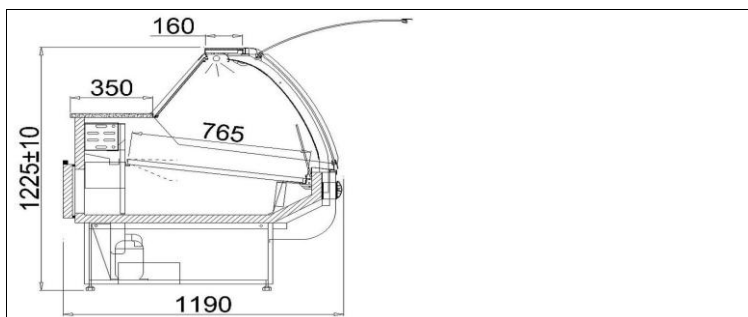

STANDARD

- device available for line setup
- internal refrigerating unit
- external housing made of zinc coated plate powder painted - white
- storage chamber made of stainless plate
- exposition area made of stainless plate
- aluminium sections - color selection possible - silver/gold
- electronic control with digital temperature display
- dynamic cooling
- automatic defrosting
- condensate outlet to container
- sound alarm indicating condenser impurity or fan operation failure*
- front panel warm air blast
- work surface - granite, grey
- high front panel - bent from hardened glass
- front panel lifting telescopic system
- light - "meat" fluorescent lamp
- night roller blind
- back door
- ecological polyurethane foam insulation
- front fender - color selection possible
- device levelling stands

Colour scheme

Paint colors

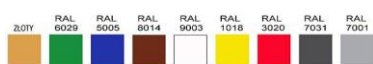

Base fender colors



Granite colors



Aluminium sections colors



ABS sides



Technical parameters

Cooling factor	R507
Length without sides [mm]	1920
Depth[mm]	1190
Side thickness [mm]	40
Cooling power [W]	800
Rated power [W]	571
Rated power of lighting [W]	58
Rated voltage [V]	230/50Hz
Shelf load [kg/linear metre]	50
Usable capacity of cold chamber [dm ³]	325
Cooling area of shelves [m ²]	1,5
Evaporation temperature To [°C]	-10
Unit weight [kg]	200
Height [mm]	1225+/-10
Range of temperature [°C]	+2/+8
Cooling power demand [W/linear metre]	400
Electricity consumption [kWh/24h]	9,1

Additional chooser options

- light - "white" fluorescent lamp
- light - "confectionery" fluorescent lamp

Additional options add. cost

- automatic condensate vaporization
- work surface - granite, Balmoral
- side panels of ABS plastic - color selection possible
- extra charge on front panel and/or base colour - colour selection possible
- temperature recorder *
- plug with fuse
- front shelf for client
- step exposition shelf (2 or 3 steps)
- Fixed vertical barrier (from the length of 1,7 up to 2,5)
- movable glass partition

-Air temperature + 25 °C, air humidity 65% -Data alteration reserved * -only using IGLOO thermostat